

Packaging Information / Reference Pattern Layout Dimensions

● USP-4

Unit: mm

■ Packaging Information

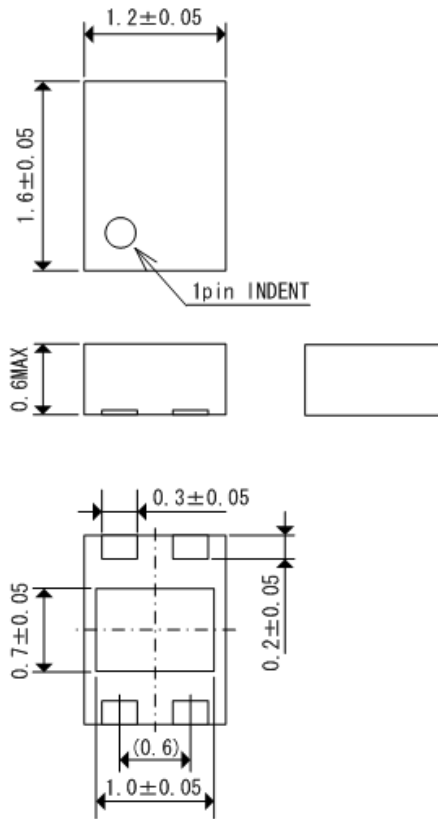

■ Reference Pattern Layout Dimension

Note : reference metal mask design

