

XC9281B33E0R-G Evaluation Board User Manual

5.5V/0.6A Step-down DC/DC Converter with HiSAT-COT Control

CAUTION

ENGINEERING EVALUATION PURPOSES ONLY

This evaluation board is made for the purpose of the product evaluation. It is strictly prohibited to use this evaluation board for any other purpose.

Torex Semiconductor does not guarantee that all samples will perform in exactly the same way and we recommend that you always consult our product data sheets for the minimum and maximum specifications.

It is also important that you evaluate all our products carefully before mass

XC9281B33E0R-G Evaluation Board

HiSAT-COT Control, 0.6A Synchronous Step-Down DC/DC Converters

Evaluation Board Picture

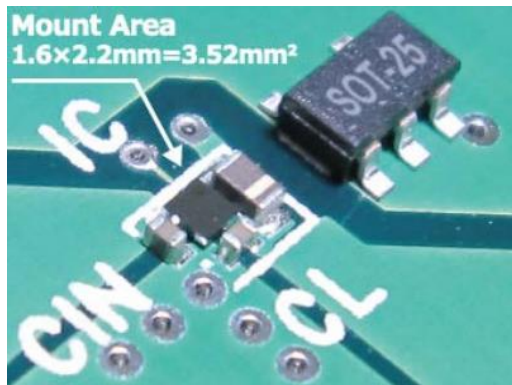

Evaluation Board SPEC

						Ta=25°C
		CONDITON.	MIN.	TYP.	MAX.	UNIT
Vin	Input Voltage Range	-	2.5	-	5.5	V
Vout	Setting Output Voltage	-	-	3.3	-	V
Iout	Output Current	-	0	-	600	mA
fosc	Switching frequency	-	-	6.0	-	MHz

XC9281/XC9282 Series Features

- Input Voltage Range 2.5V ~ 5.5V
- Output Voltage Range 0.7V ~ 3.6V (step 0.05V)
- Max Output Current 600mA max.
- Switching frequency 4MHz or 6MHz
- Max Duty Cycle 100%
- Small Solution Size 3.52 mm²

- Fast Load Transient Response
- 0.6 x 0.3mm Ceramic Cap. Available
- Low EMI Noise

XC9281B33E0R-G Evaluation Board

HiSAT-COT Control, 0.6A Synchronous Step-Down DC/DC Converters

Quick Start Procedure

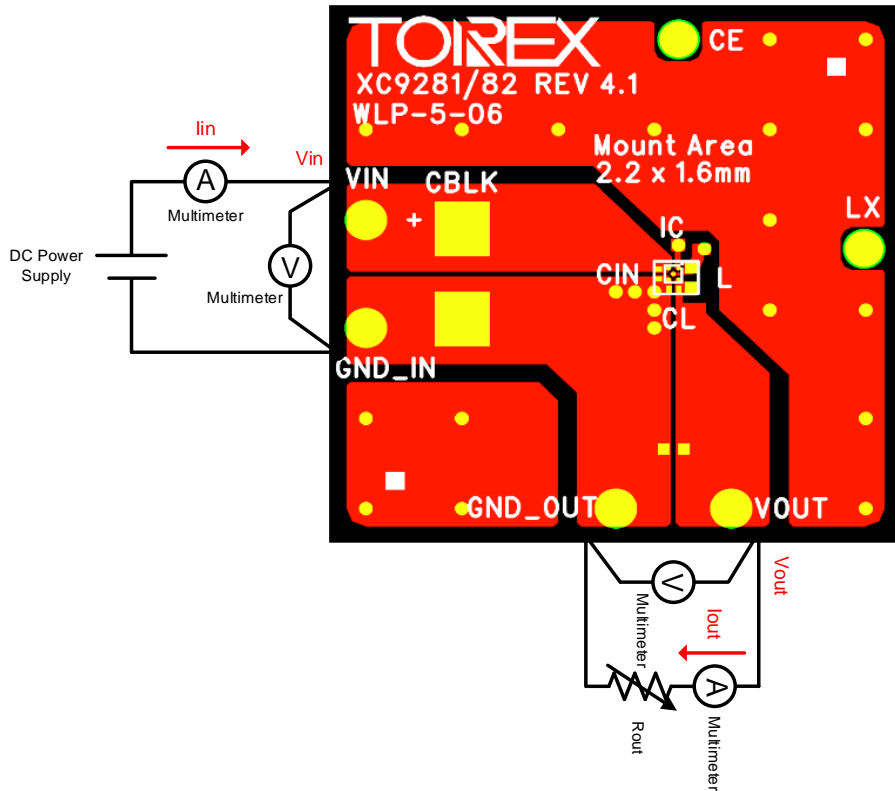

XC9281B33E0R-G Evaluation Board

HiSAT-COT Control, 0.6A Synchronous Step-Down DC/DC Converters

Schematic

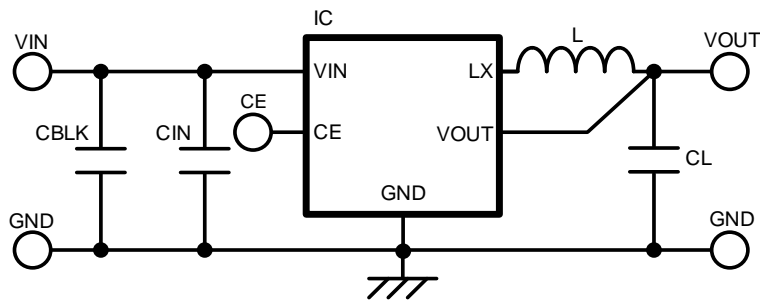

BOM

Required Circuit Component

Item	Value	Description	Size [mm]	Part Number	Manufacture
IC	-	5.5V/0.6A Step-down DC/DC	WLP-5-06	XC9282B33E0R-G	TOREX
L	0.47uH	Inductor, 0.47uH	1005	MCEE1005TR47MHN	Taiyo Yuden
CIN	4.7uF	Ceramic cap., 6.3V/4.7uF	0603	GRM035R60J475ME15D	Murata
CL	4.7uF	Ceramic cap., 6.3V/4.7uF	0603	GRM035R60J475ME15D	Murata

Additional Demo Board Circuit Components

Item	Value	Description	Size [mm]	Part Number	Manufacture
CBLK	10uF	Ceramic cap., 50V/10uF	3225	CGA6P3X7S1H106K	TDK

XC9281B33E0R-G Evaluation Board

HiSAT-COT Control, 0.6A Synchronous Step-Down DC/DC Converters

PCB Layout

Layer 1

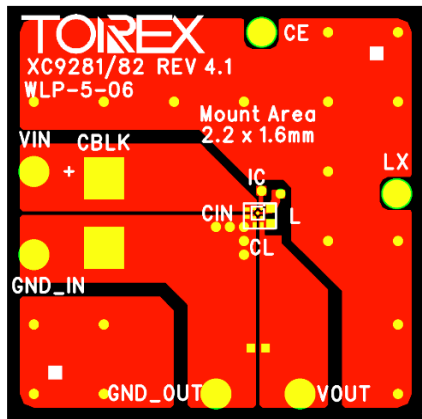

Layer 2

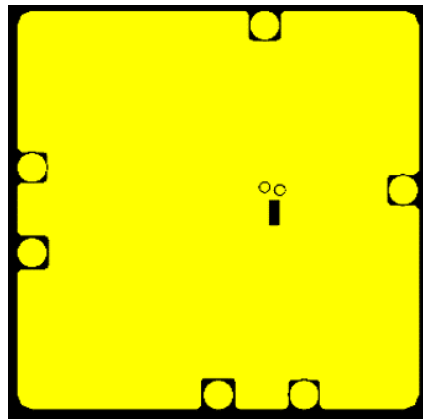

Layer 3

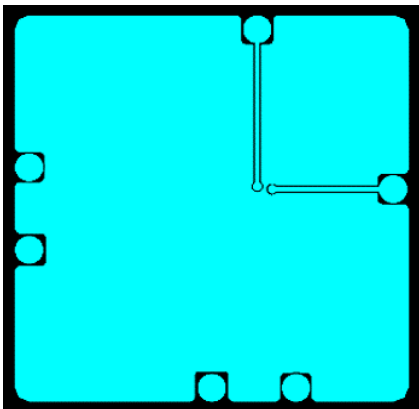

Layer 4

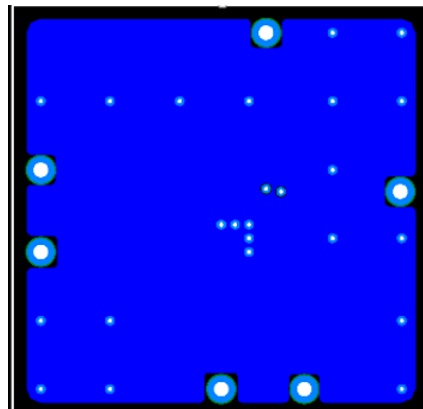

XC9281B33E0R-G Evaluation Board

HiSAT-COT Control, 0.6A Synchronous Step-Down DC/DC Converters

Test Result

(1) Output Voltage vs Output Current @Ta=25°C

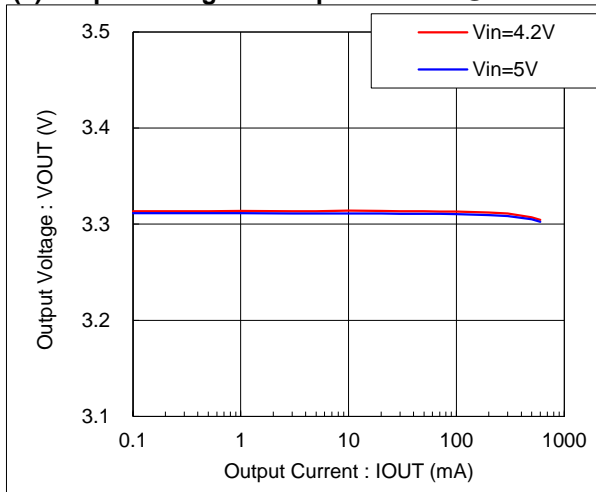

(2) Efficiency vs Output Current Ta=25°C

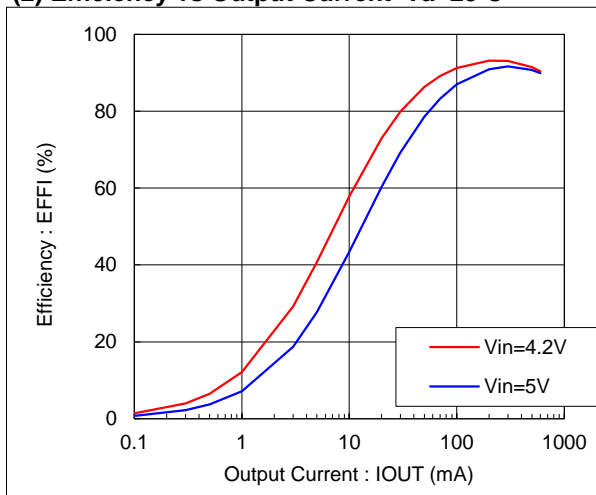

(3) Ripple Voltage vs Output Current Ta=25°C

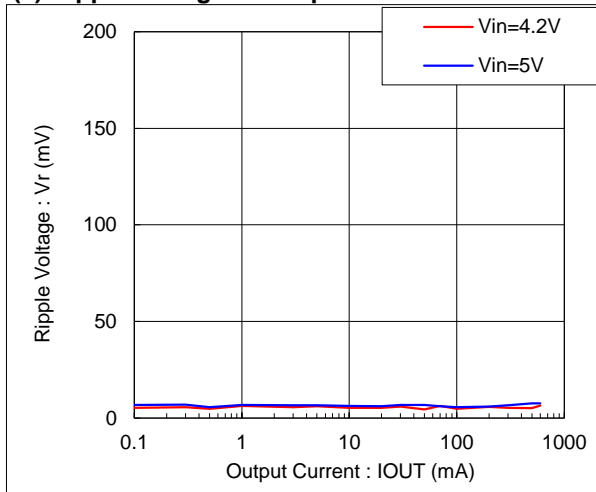

XC9281B33E0R-G Evaluation Board

HiSAT-COT Control, 0.6A Synchronous Step-Down DC/DC Converters

Test Result

(4) Output Voltage Waveform @ Ta=25°C

(4-1) Vin = 5.0V, Iout = 1mA

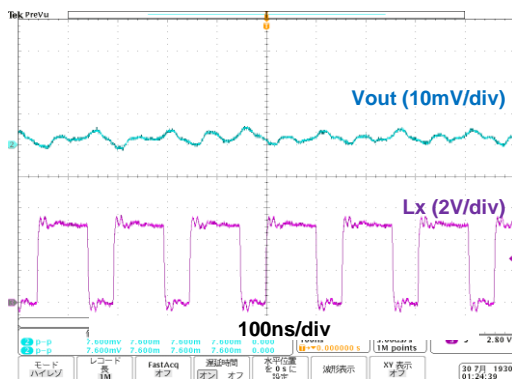

(4-2) Vin = 5.0V, Iout = 300mA

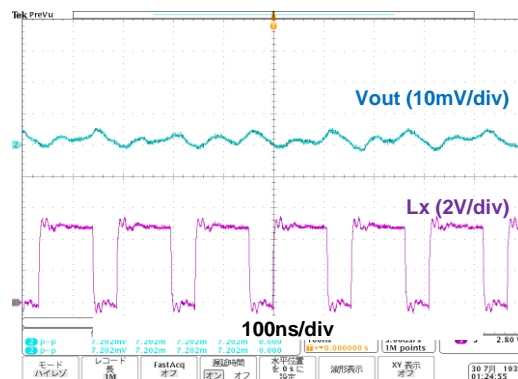

XC9281B33E0R-G Evaluation Board

HiSAT-COT Control, 0.6A Synchronous Step-Down DC/DC Converters

Test Result

(5) Start-up Waveform @ Ta=25°C

(5-1) Vin = 5V, Iout = 10mA

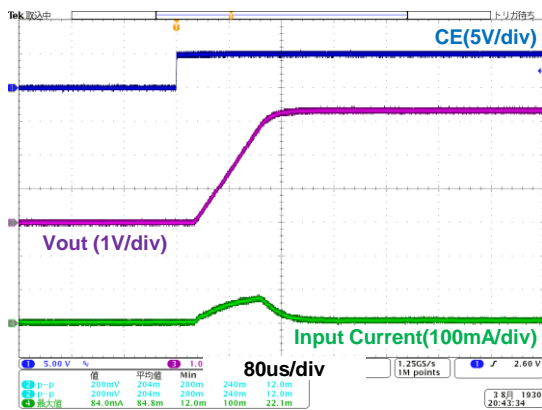

(5-2) Vin = 5V, Iout = 300mA

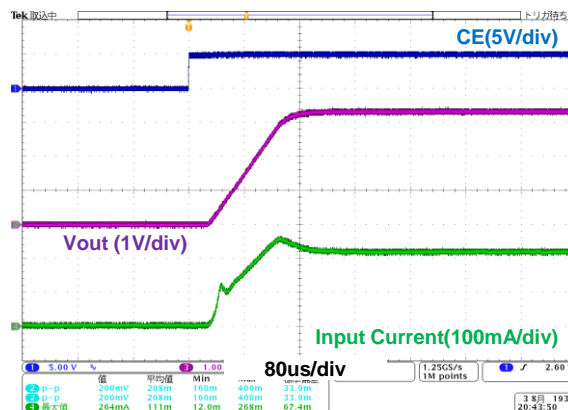

XC9281B33E0R-G Evaluation Board

HiSAT-COT Control, 0.6A Synchronous Step-Down DC/DC Converters

Test Result

(6) Load Transient Waveform @ Ta=25°C

(6-1) Vin = 5V, Iout = 1mA ↔ 300mA

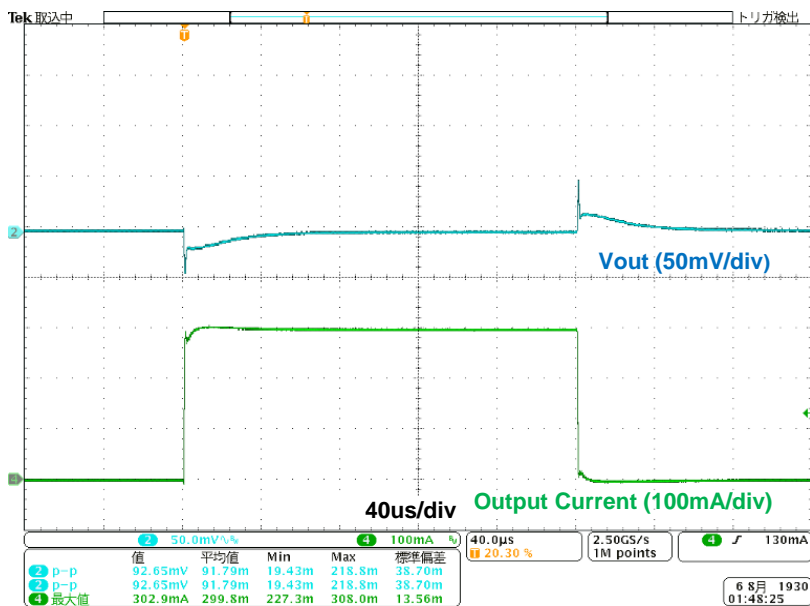

XC9281B33E0R-G Evaluation Board

HiSAT-COT Control, 0.6A Synchronous Step-Down DC/DC Converters

Test Result

(7) Radiation EMI : VCCI 10m

Condition

IC : XC9282B18ER-G

Vin : 3.7V

Vout : 1.8V

Iout : 100mA

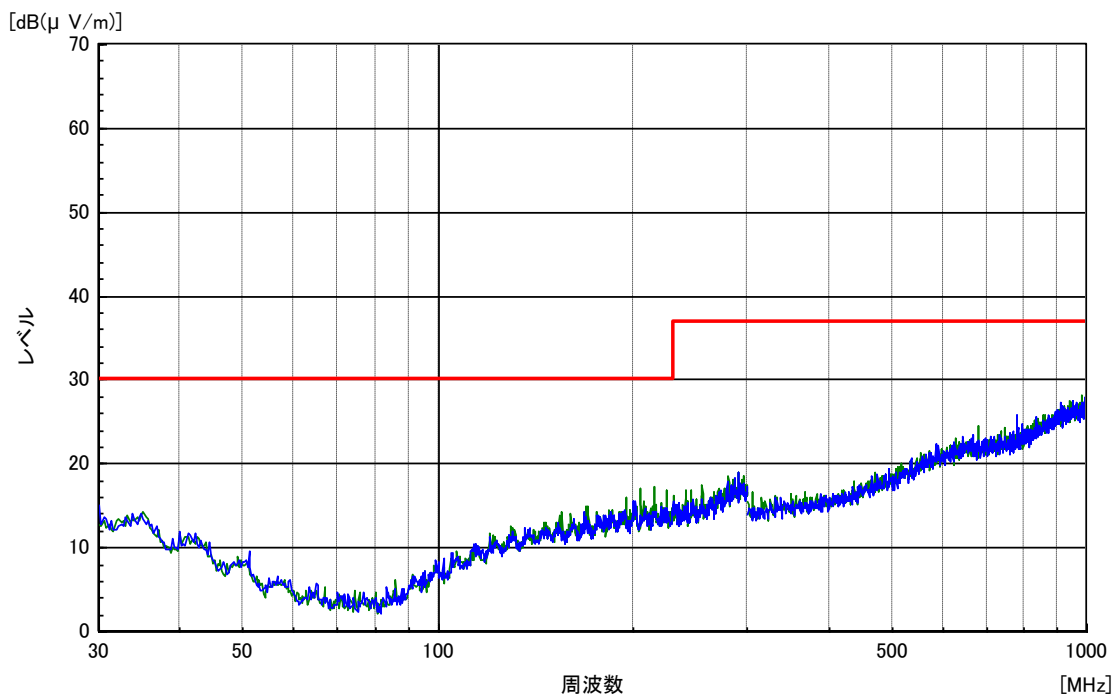

XC9281B33E0R-G Evaluation Board

HiSAT-COT Control, 0.6A Synchronous Step-Down DC/DC Converters

【Appendix】 How to calculate DC/DC Converter or DC/DC Controller.

It can be calculated by the following "WEB DC/DC Simulation".

Product	XC9281 Product Info	Schematic Summary	Waveform	Efficiency Tj, Duty	Ripple Voltage Vin Voltage	Coil Current Input Current	Switching frequency
Switching frequency	<input type="radio"/> 4000 [kHz] <input checked="" type="radio"/> 6000 [kHz]	<div style="border: 1px solid gray; padding: 5px;"> <h3>Efficiency</h3> <h3>Loss Ratio</h3> </div>					
Control Method	<input checked="" type="radio"/> F-PWM						
Sim Condition							
Vin	3.6 [V] Range: 2.5V~5.5V						
Vout	3.3 [V] Range: 0.7V~3.6V						
Iout	100 [mA] Range: 0~600mA						
Rvin (Battery Impedance etc)	0 [Ω]						
Ta	25 [°C] Range: -40~105°C						
Thermal resistance: θja	125 [°C/W] Range: 0~1000°C/W						
External Components							
L	0.47 [μH]						
DCR	60 [mΩ]						
CL (Effective Value)	2.35 [μF]						
ESR	10.64 [mΩ]						

- 日本語 : <https://www.torex.co.jp/technical-support/dcdc-simulation/>
- English : <https://www.torexsemi.com/technical-support/dcdc-simulation/>
- 简体中文 : <https://www.torex.com.cn/technical-support/dcdc-simulation/>

XC9281B33E0R-G Evaluation Board

HiSAT-COT Control, 0.6A Synchronous Step-Down DC/DC Converters

[Appendix] How to reduce the spike noise caused by measurement (Probing method with oscilloscope)

Probing method : Before improvement

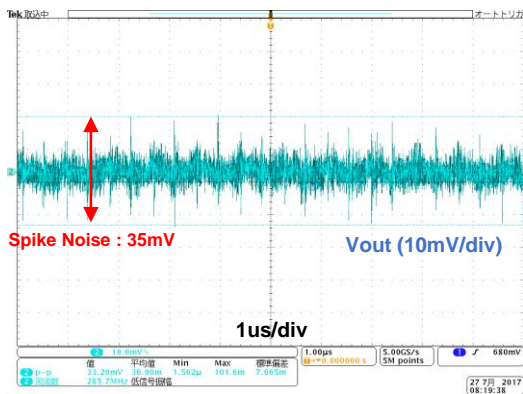
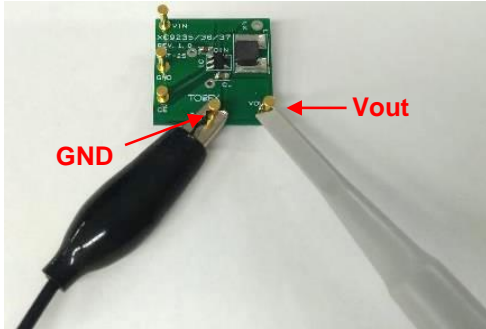

Probing method : After

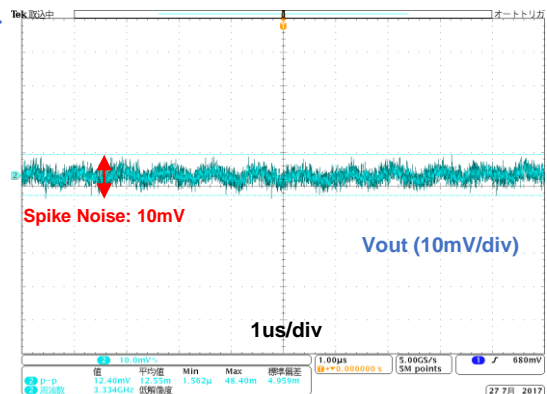
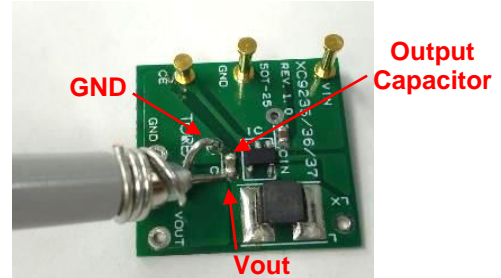

* Condition : XC9236, Vin=3.6V/Vout=1.8V/100mA

English : <https://www.torexsemi.com/technical-support/tips/reduction-spike-noise/>

日本語 : <https://www.torex.co.jp/technical-support/tips/reduction-spike-noise/>